

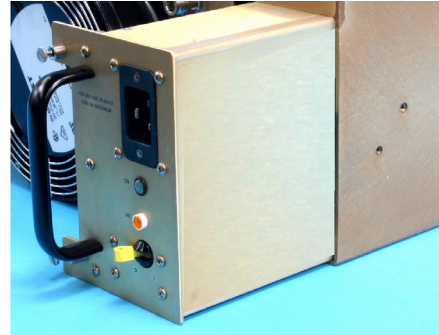

XTRS-50C C-Band Rack Mount Solid State Power Amplifiers



Front Panel



Rear Panel showing Power
Supply Partially Removed

- **50 Watt**
- **Built-in Redundancy Control**
 - 1:1**
 - 1:1 with load switching**
 - 1+1 Soft Fail**

- **Complete Digital M&C Interface**
 - Ethernet**
 - RS-232**
 - RS-485**
- **Removable Power Supply**

The XTRS-50C is a highly efficient rack-mountable solid state power amplifier (SSPA) designed for fixed and mobile uplink applications.

RF filters, isolators, cooling, and monitor and control (M&C) systems are all self-contained within the package.

Rack space is conserved because the amplifiers occupy only 4 rack units (7 inches) of a standard 19 inch rack cabinet. Nominal weight is 80 pounds.

The unit features a menu driven front panel display, RS-232/422/485 serial port and Ethernet interfaces for complete computer control. Forward power, reverse power and temperature, and default parameters are easily monitored on the four line front panel display.

Gain control is provided via the front panel or through the remote interfaces.

A high frequency resonant conversion power supply is used that accepts a wide range of prime power (90 to 264 VAC). Power factor correction circuitry is

also included which minimizes line current distortion and reduces the required Volt-Amps input.

Depending upon user requirements, this high power amplifier can be configured for single thread, redundant, or phase combined configurations.

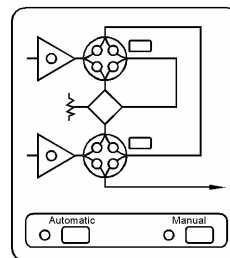

1+1 Soft Fail

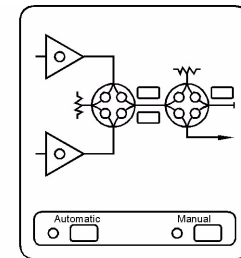

1:1 Configuration
with Load Switching

Front Panel Redundancy Options

PERFORMANCE SPECIFICATIONS

Parameter	XTRS-50C	
FREQUENCY RANGE standard extended frequency coverage available	5.85 - 6.425 GHz	5.85 - 6.65 GHz (Option C1)
OUTPUT POWER		
Saturated Power (Typical)	47 dBm	47 dBm
Rated Power(P1dB) @ Amplifier Flange	46 dBm	46 dBm
GAIN		
Small Signal, minimum	65 dB, gain control set for maximum gain	
Small Signal, maximum	75 dB, gain control set for maximum gain	
Gain Flatness, maximum	2.5 dB	
Maximum SSG Variation Over 40 MHz	0.8 dB per 40 MHz	
Slope, maximum	± 0.04 dB/MHz	
Stability, 24 Hr maximum	± 0.25 dB	
Stability, Temperature	± 2 dB maximum over temperature range at any frequency	
GAIN CONTROL	20 dB	
INTERMODULATION with two signals	- 25 dBc maximum with two equal carriers at 3 dB total power backoff from rate output	
HARMONIC OUTPUT, maximum	- 60 dBc	
AM/PM CONVERSION, maximum	2.5 deg/dB at 3 dB below rated output power	
NOISE POWER, maximum		
Transmit Band	- 80 dBW/4 kHz	
Receive Band	- 150 dBW/4 kHz 3.7 to 4.2 GHz	
GROUP DELAY, maximum		
Bandwidth	Any 40 MHz	
Linear	± 0.03 nS/MHz	
Parabolic	± 0.003 nS/MHz ²	
Ripple	1 nS/Pk-Pk	
RESIDUAL AM	- 50 dBc to 10 kHz - 20 (1.5 + logf) dBc 10 to 500 kHz - 85 dBc above 500 kHz	
PHASE NOISE, maximum	10 dB below IESS phase noise profile	
VSWR		
Input, maximum	1.2:1	
Output, maximum	1.3:1	

PRIME POWER

Working Range 90 MIN. - 264 MAX., VAC
 47 to 63 Hz, single phase
 400 VA Typical
 0.95 Minimum Prime Power Factor



OPTIONS

- Extended Frequency
5.85-6.65 GHz
Option C1
- Redundancy Control
1:1
Option 29
1:1 w/load Switching
Option 30
1+1 Soft Fail
Option 31
- Built-in L-Band Block Upconverter
Option B1
Frequencies Available:
5.85-6.425 GHz
5.85-6.65 GHz

ENVIRONMENT

NONOPERATING TEMPERATURE RANGE	-50° C to +70° C
OPERATING TEMPERATURE RANGE	0° C to +50° C 2° C/1000 feet derating
HUMIDITY	Up to 95% Noncondensing
ALTITUDE	12,000 feet MSL maximum
SHOCK AND VIBRATION	Normal Transportation
COOLING	Forced Air (60 CFM Typical)

INTERFACE

TYPE	FUNCTION			
CONTROLS	Local	Local/remote	AC Power ON/OFF	
	Local and Remote	Gain	Transmit ON/OFF	
		Min/Max Power Alarm/Fault	Audio Alarm ON/OFF	
		Reflected Power Alarm/Fault	Units (Watts, dBm, dBW)	
STATUS	Front Panel LEDs	Standby	Transmit	
		Local	Remote	
		Summary Fault		
	Front Panel Digital Display	Power Out	Attenuator Setting	Faults:
		Reflected Power	Units Selection	High VSWR
		Temperature	Standby Hours	Temperature
		Transmit Hours		Power Supply
Dry Form-C Relay Contacts (Two)	Summary Fault			
COMPUTER	Hardware Interface	2 ports: RS-232 & RS-422/RS-485 1 port: Ethernet		
SERIAL PORT	Xicom Command Set	ASCII Commands		
RF SAMPLE PORT COUPLING		-40 dB Nominal		

XTRS-50C High Power Solid State Amplifiers



Block Diagram

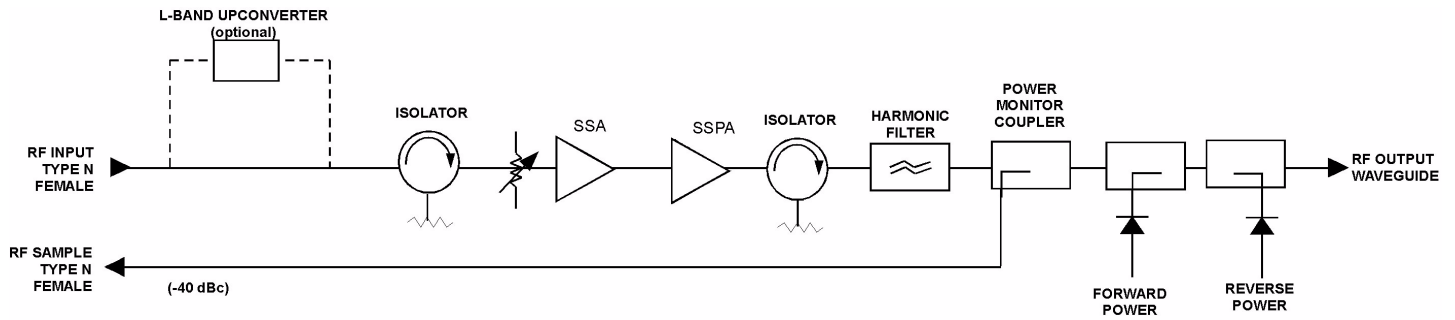

Outline Drawing

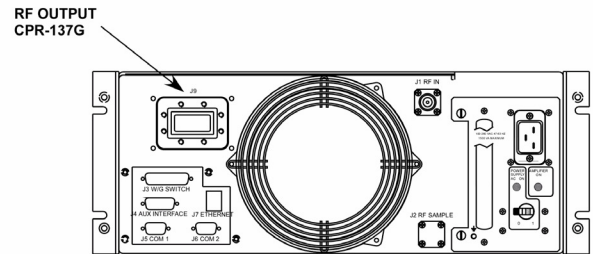
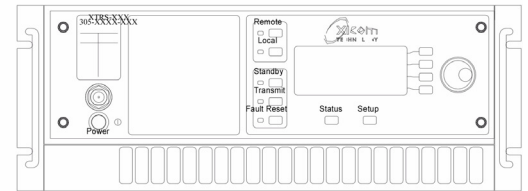
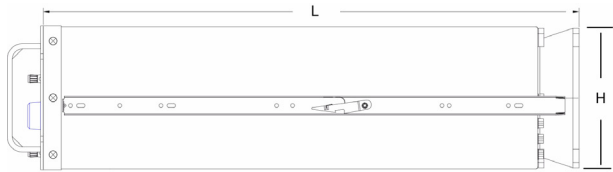

WEIGHT (TYPICAL)	
80 LBS	36.29 kg

	DIMENSIONS	
	INCHES	CENTIMETERS
L	25.25	64.135
W	17.00	43.18
H	6.969	17.70

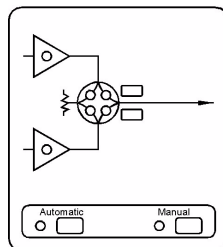

Redundant 1:1

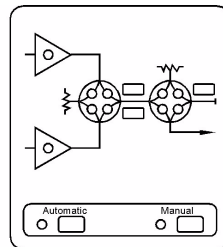

Redundant 1:1
with Load Switching

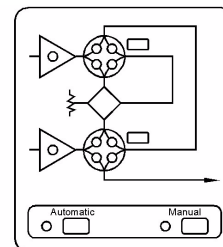

1+1 Soft Fail



Document # 805-1505-001 09/23/2004
XTRS-50C REV 7
© 2004

Note: Technical specifications are subject to change without notice. Please contact Xicom Technology before using this information for system design.

3550 Bassett Street • Santa Clara, CA • 95054
Tel: (408) 213-3000 • Fax: (408) 213-3001

www.xicomtech.com