

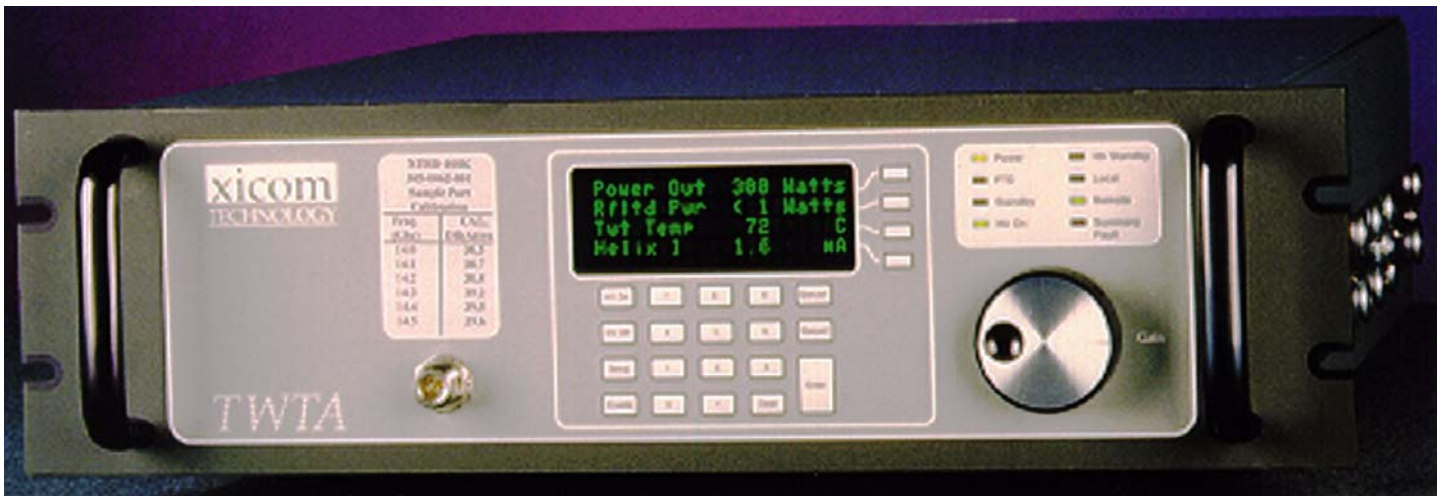

XTRD-100DB Dual-Band Rack Mount High Power Amplifier



- **100 Watts**
- **Power Factor Correction**

- **Digital Display & Control Interface**
- **High Efficiency**

The XTRD-100DB is a highly efficient rack-mountable traveling wave tube (TWT) amplifier designed for fixed and mobile uplink applications.

The unit includes RF gain control, a solid state pre-amplifier, RF filters, cooling, and monitoring & control (M&C) systems..

Rack space is conserved because the amplifier occupies only 3 rack units (5 ¼ inches) of a standard 19 inch rack cabinet. Nominal weight is 50 pounds.

The unit features a menu driven front panel display, RS-232/422/485 serial port interfaces for complete computer control. RF, traveling wave tube, and default parameters are easily monitored on the four line front panel display.

Gain control is provided via the front panel or through the serial interface.

The XTRD-100DB amplifier incorporates high efficiency dual-stage collector TWTs. Reliability is enhanced because both prime power consumption and internal operating temperatures are reduced for both the linear and saturated modes of operation.

Power factor correction circuitry is also included which minimizes line current distortion and reduces the required Volt-Amps input.

The automatic features of the high frequency resonant conversion power supply include quick recovery from prime power supply outages and multiple helix fault resets (three fault cycles).

Depending upon user requirements, this high power amplifier can be configured for either single thread or redundant system operation.

PERFORMANCE SPECIFICATIONS

Parameter	C-Band XTRD-100DB	Ku-Band XTRD-100DB
FREQUENCY RANGE	5.85 to 6.425 GHz*	14.0 to 14.5 GHz
*Extended other frequency coverage available		13.75 to 14.5 GHz
OUTPUT POWER		
Saturated Power (typical)	100 W	95 W
Rated Power @ Amplifier Flange	90 W	85 W
GAIN		
Large Signal, minimum	57 dB	57 dB
Small Signal, minimum	62 dB	62 dB
Attenuator Range (continuous)	20 dB	20 dB
Maximum SSG Variation Over:		
Any Narrow Band	1.5 dB per 40 MHz	1.3 dB per 80 MHz
Full Band	2.5 dB	2.5 dB
Slope, maximum	±0.04 dB/MHz	±0.04 dB/MHz
Stability, 24 Hr maximum	±0.25 dB	±0.25 dB
Stability, Temperature	±1.0 dB maximum over temperature range at any frequency	
INTERMODULATION with two equal signals	-17 dBc maximum with two equal carriers @ 4 dB total output backoff	
HARMONIC OUTPUT, maximum*	-3 dBc @ 49 dBm	-12 dBc
AM/PM CONVERSION, maximum	2.5°/dB @ 6 dB below rated power	
NOISE POWER, maximum*		
Transmit Band	-64 dBW/4 kHz	-64 dBW/4 kHz
Receive Band	-64 dBW/4 kHz 3.7 to 4.2 GHz	-64 dBW/4 kHz 10.95 to 12.75 GHz
GROUP DELAY, maximum		
Bandwidth	Any 40 MHz	Any 80 MHz
Linear	0.01 nsec/MHz	0.01 nsec/MHz
Parabolic	0.005 nsec/MHz ²	0.005 nsec/MHz ²
Ripple	0.5 nsec/Pk-Pk	0.5 nsec/Pk-Pk
RESIDUAL AM NOISE, maximum In band discrete spurious	-50 dBc to 10 kHz -20(1.5 log F) dBc 10 to 500 kHz -85 dBc above 500 kHz	
PHASE NOISE, maximum	10 dB below IESS phase-noise profile AC fundamental -50 dBc Sum of all spurs -47 dBc	
VSWR		
Input, maximum		1.3:1
Output, maximum		2.2:1

*Harmonic/receive band filtering not included

PRIME

100-260 VAC
47 to 63 Hz, single phase
650 Maximum Input VA
0.95 Minimum Prime Power Factor

OPTIONS

Extended Frequency Coverage
1:1, 1:2, 1:N Redundancy
Variable Phase Power Combining
Integrated Linearizers



ENVIRONMENT

NONOPERATING TEMPERATURE RANGE	-50° C to +70° C
OPERATING TEMPERATURE RANGE	-10° C to +50° C
HUMIDITY	Up to 95% Noncondensing
ALTITUDE	10,000 feet MSL maximum
SHOCK AND VIBRATION	Normal Transportation
COOLING	Forced Air

INTERFACE

	TYPE		FUNCTION		
CONTROLS	Local	Local/remote	AC Power ON/OFF		
	Local and Remote	Gain	High Voltage ON/OFF	Fault Reset	
		Min/Max Power Alarm/Fault	Audio Alarm ON/OFF	Lamp Test	
		Reflected Power Alarm/Fault	Units (Watts, dBm, dBW)	Heater Standby ON/OFF	
STATUS	Front Panel LEDs	Power	Heater Time Out (FTD)	Standby	
		High Voltage	Heater Standby	Local Mode	
		Remote Mode	Summary Fault		
	Front Panel Digital Display	Power Out	Reflected Power	Faults:	
		TWT Temperature	Helix Current	High VSWR	
		Helix Voltage	Heater Hours	High Voltage	
Beam Hours			helix Current		
	Dry Form-C Relay Contacts (Two)	Summary Fault	TWT Temperature		
SERIAL PORT		RS-232/RS-422/RS-485			
RF SAMPLE PORT COUPLING		-37 dB Nominal			

XTRD-100DB Dual-Band HIGH POWER AMPLIFIERS



Block Diagram

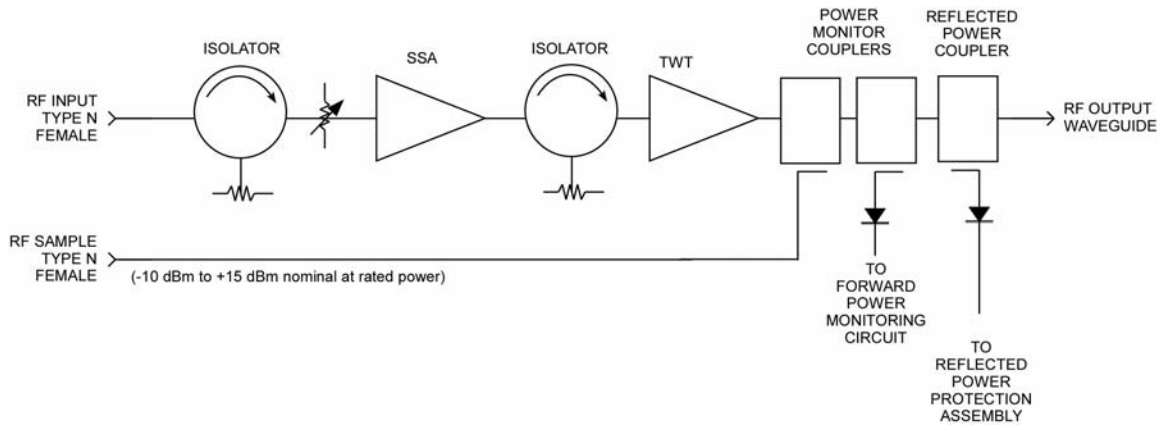

Outline Drawing

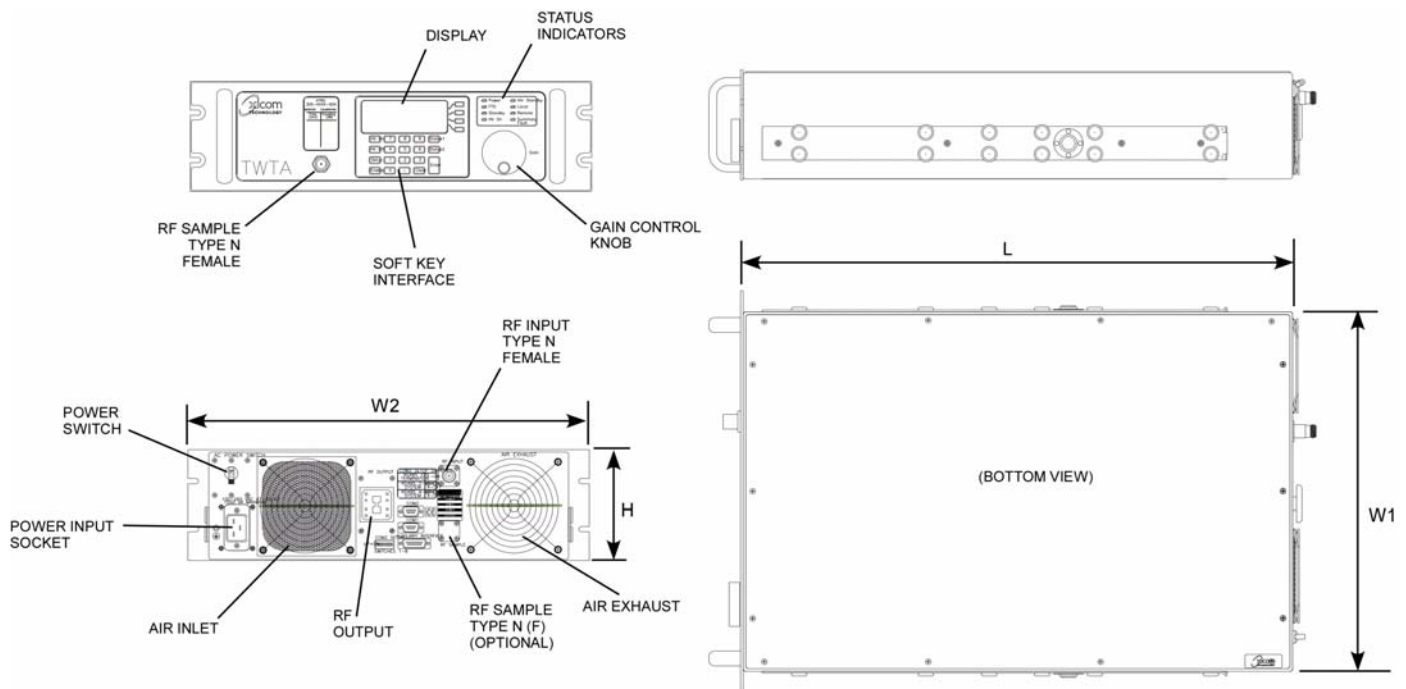

DIMENSIONS		
	INCHES	CENTIMETERS
L	26.00	66.04
W1	17.00	43.18
W2	19.00	48.26
H	5.219	13.26
Nominal Weight: 50 lbs (22.68 kg)		